

PT3931 24V Single coil Hall Driver IC

Applications

- Single coil DC brushless motor
- Support pre-driver application

Features

- Built-in hall sensor
- Single phase full wave driver
- Soft switching output driver
- Motor locked protection and automatic restart
- Built-in hysteresis comparator
- Built-in zener diode
- High balance and low thermal drift magnetic sensing
- Low power consumption and high driving efficiency

Specifications

Absolute Maximum Ratings (Ta=25°C)

Parameter	Symbol	Conditions	Rating	Units
Maximum supply voltage	VDDmax		34.5	V
Allowable power dissipation	Pd		658 ^{*1}	mW
Operating temperature	Ta		-40~+100	°C
Storage temperature	Ts		-50~+150	°C
Max. output current	I _{OMAX}	0.5sec	800 ^{*2}	mA
Thermal resistance	Θ _{aj}		190	°C/W
Maximum Junction temperature	T _{jmax}		150	°C

*1: Reduced by 5.26mW for each increase in Ta of 1°C over 25°C When mounted on 50mm x 50mm x 1.6mm glass epoxy board

*2: Should not exceed Pd

◆ All PROLIFIC products described or contained herein do not have specifications that can handle applications require extremely high levels of reliability, such as life-support systems, aircraft control systems, or other applications whose failure can be reasonably expected to result in serious physical and/or material damage. Consult with your PROLIFIC representative nearest you before using any PROLIFIC products described or contained herein in such applications.

◆ PROLIFIC assumes no responsibility for equipment failures that result from using products at values that exceed, even momentarily, the rated values (such as maximum ratings, operating condition ranges, or other parameters) listed in products specifications of any and all PROLIFIC products described or contained herein.

Package: TO-92-4pin

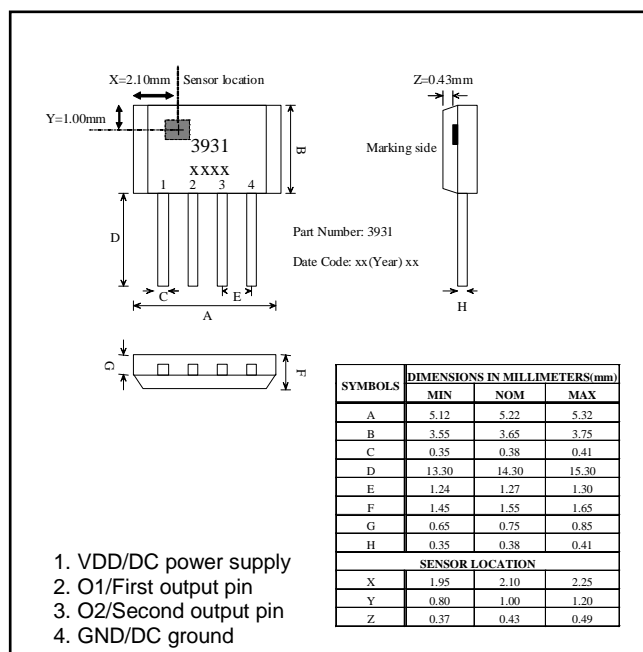

Electrical Characteristics (T_A=+25°C, V_{DD}=24V)

Characteristic	Symbol	Test Condition	Min.	Typ.	Max.	Units
Supply Voltage	V _{DD}		4.5		30	V
Output High Voltage	V _{OH(ON)}	@ I _{OUT} =200mA	V _{DD} -0.6	V _{DD} -0.4		V
Output Low Voltage	V _{OL(ON)}	@ I _{OUT} =200mA		0.4	0.6	V
Output Voltage Clamp	V _{BV}		35			V
Supply Current	I _{DD}	Output open		6	10	mA
Shutdown Time	T _{SD}		2.8	3.5	4.2	S
Restart Time	T _{RS}		0.4	0.5	0.6	S

Magnetic Characteristics (T_A=+25°C, V_{DD}=24V)

Operate Point	B _{OP}		-	15	35	G
Release Point	B _{RP}		-35	-15	-	G
Hysteresis	B _{HYS}		20	30	60	G

General Specifications

The PT3931 is designed for magnetic actuating using a bipolar magnetic field. The built-in dynamic offset cancellation of pre-amplifier stage achieves optimal symmetrical magnetic sensing. The output driver provides a linear drive to eliminate switching noise. This Hall-effect IC is optimal for DC brushless fan application. The supply voltage range is from 4.5V to 30V.

Lock Protection

In order to protect the motor, the driver IC will be shutdown to drive the coil when the motor is locked over 0.4 seconds. Then, it restarts to drive the motor after 2.8 seconds. Figure 1 shows the timing diagram between the hall input signal and driver's output state.

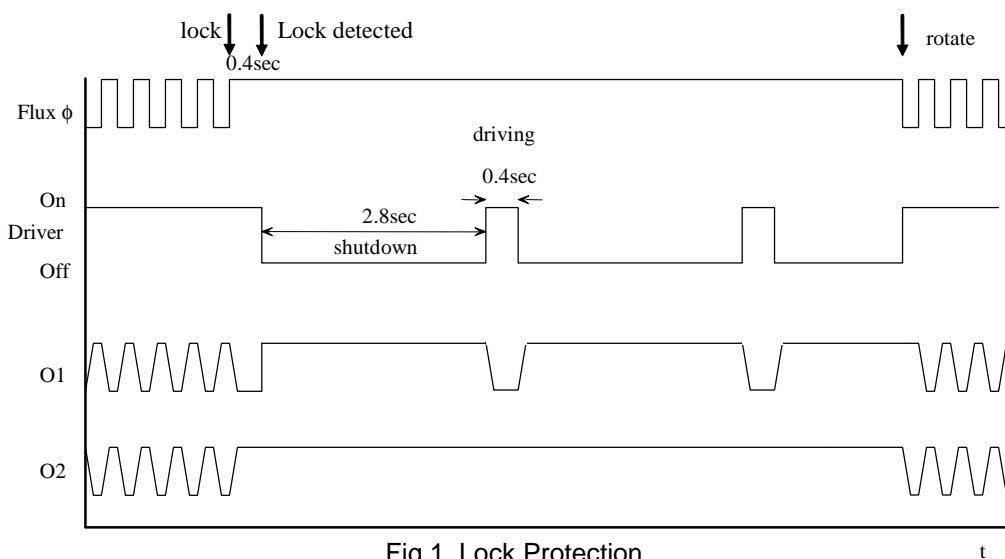

Fig 1. Lock Protection

Hall Sensor

This Hall effect sensor IC integrates the sensor, pre-amplifier with dynamic offset cancellation and the hysteresis comparator in single chip. The hysteresis characteristic is illustrated in Fig. 2 and the threshold of the magnetic flux density is ± 15 Gauss.

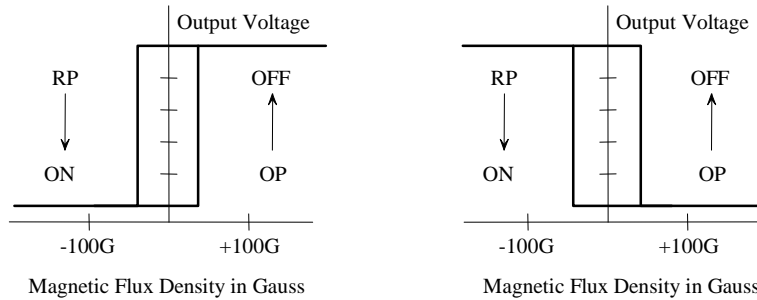

Fig 2. Magnetic Hysteresis Characteristics

The Hall Driver IC architecture block diagram is shown in Fig. 3.

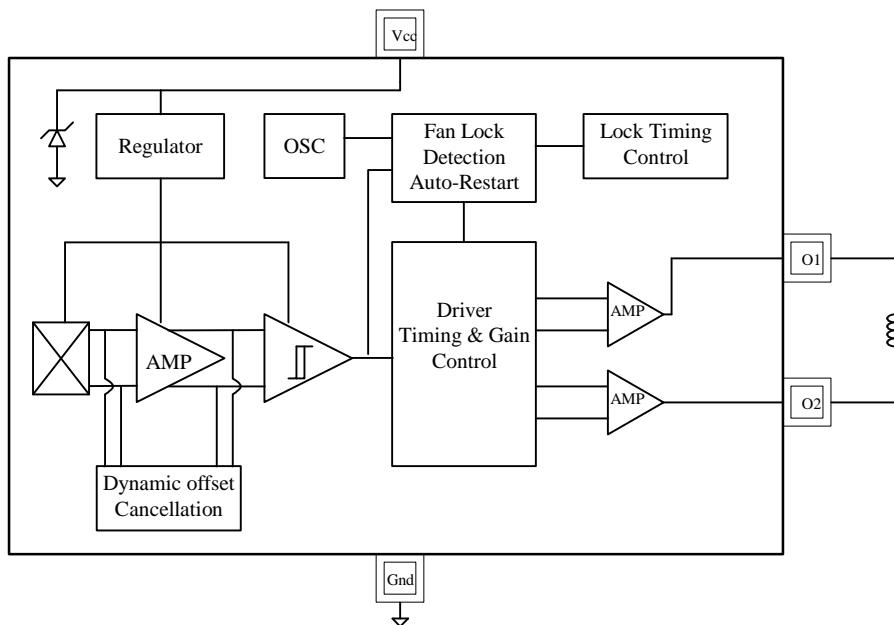
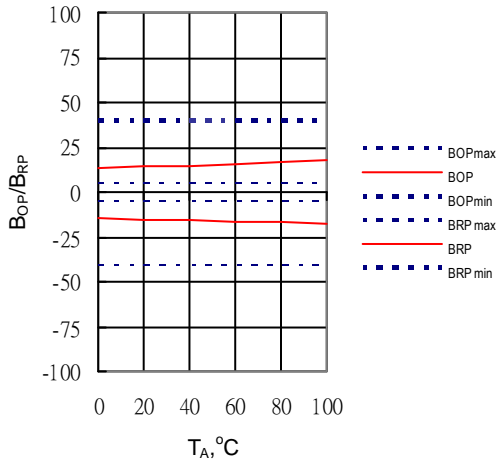
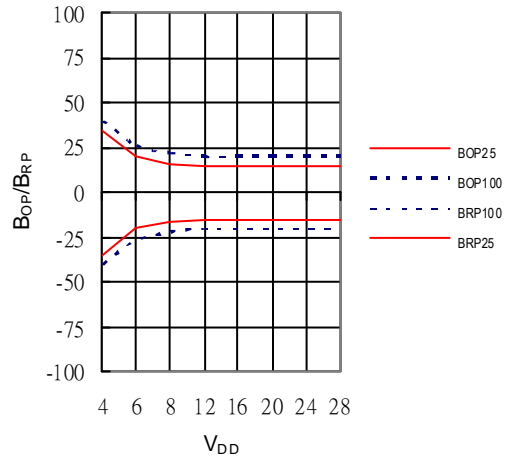
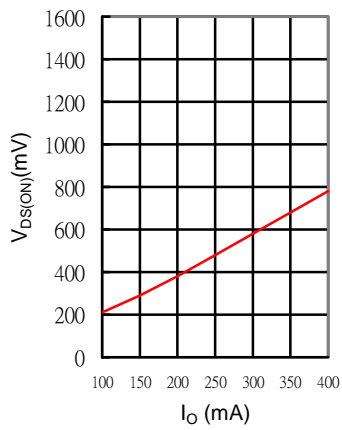
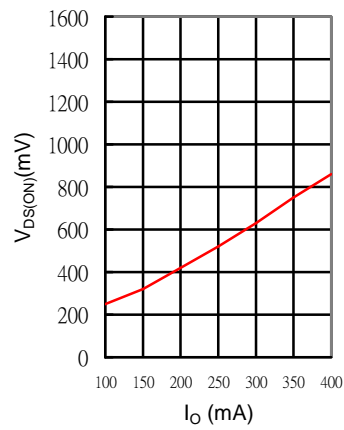
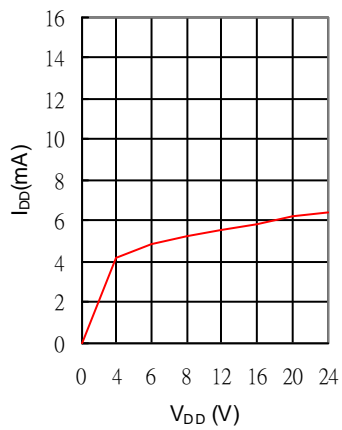
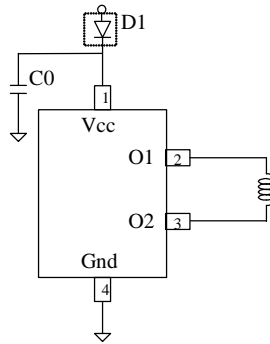

Fig. 3 Hall IC Architecture

B_{OP}, B_{RP} versus temperature

B_{OP}, B_{RP} versus supply voltage

VOL(ON) versus I_O current

VOH(ON) versus I_O current

I_{DD} versus power supply

Application circuits



C0: decoupling capacitor 1nF ~ 0.01uF

Thermal resistance

Parameter	Symbol	Conditions	Rating	Units
Allowable power dissipation	P_d		658 ^{*1}	mW
Junction to ambient thermal resistance	θ_{JA}		190	°C/W
Junction to case thermal resistance	θ_{JC}		80	°C/W
Maximum junction temperature	T_J		150	°C

*1: Reduced by 5.26mW for each increase in Ta of 1°C over 25°C When mounted on 50mm x 50mm x 1.6mm glass epoxy board

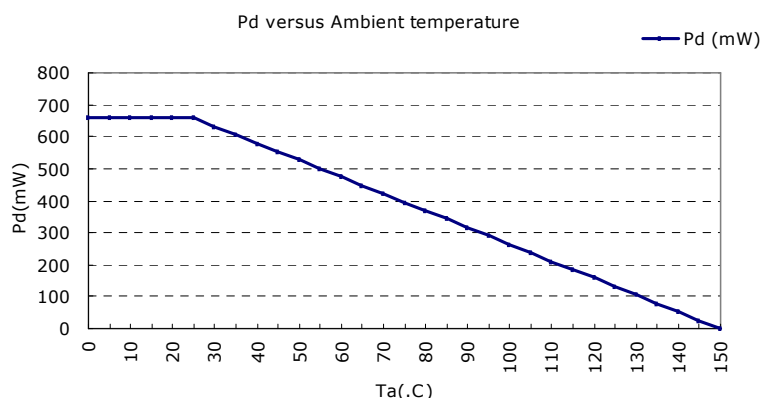

- ◆ Specifications of any and all PROLIFIC products described or contained herein stipulate the performance, characteristics, and functions of the described products in the independent state, and are not guarantees of the performance, characteristics, and functions of the described products as mounted in the customer's products or equipment. To verify symptoms and states that cannot be evaluated in an independent device, the customer should always evaluate and test devices mounted in the customer's products or equipment.
- ◆ PROLIFIC Technology Inc. strives to supply high-quality high-reliability products. However, any and all semiconductor products fail with some probability. It is possible that these probabilistic failures could give rise to accidents or events that could endanger human lives, that could give rise to smoke or fire, or that could cause damage to other property. When designing equipment, adopt safety measures so that these kinds of accidents or events cannot occur. Such measures include but are not limited to protective circuits and error prevention circuits for safe design, redundant design, and structural design.
- ◆ In the event that any and all PROLIFIC products described or contained herein fall under strategic products (including services) controlled under the Foreign Exchange and Foreign Trade Control Law of Taiwan, such products must not be exported with our obtaining export license from the Ministry of international Trade and Industry in accordance with the above law.
- ◆ No part of this publication may be reproduced or transmitted in any form or by any means, electronic or mechanical, including photocopying and recording, or any information storage or retrieval system, or otherwise, without the prior written permission of PROLIFIC Technology Inc.
- ◆ Any and all information described or contained herein are subject to change without notice due to product/technology improvement, etc. When designing equipment, refer to the Delivery Specification for the PROLIFIC product that you intend to use.
- ◆ Information (including circuit diagrams and circuit parameters) herein is for example only; it is not guaranteed for volume production. PROLIFIC believes information herein is accurate and reliable, but no guarantees are made or implied regarding its use or any infringements of intellectual property rights or other rights of third parties.

Specifications and information herein are subject to change without notice.